

COMPLIANCE	ANSI/EIA RS-310D IEC60297-2 DIN41494; Part 1 DIN41494; Part 7
LOADING CAPACITY	3,000 lbs static load

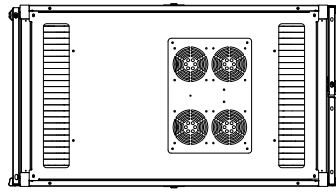

TOP VIEW

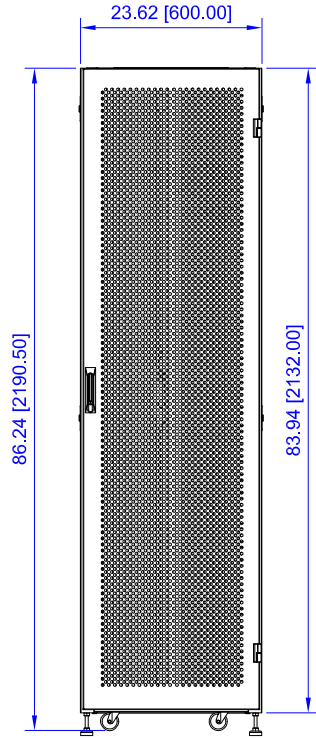
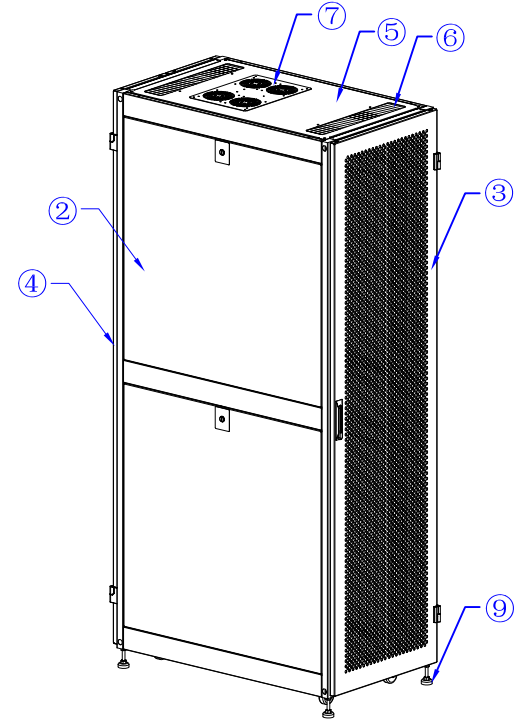
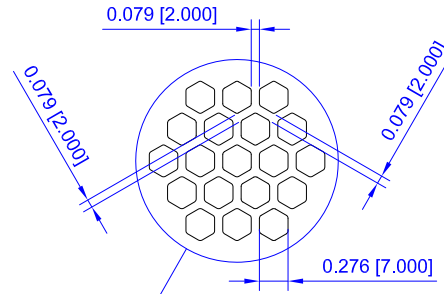

FRONT VIEW

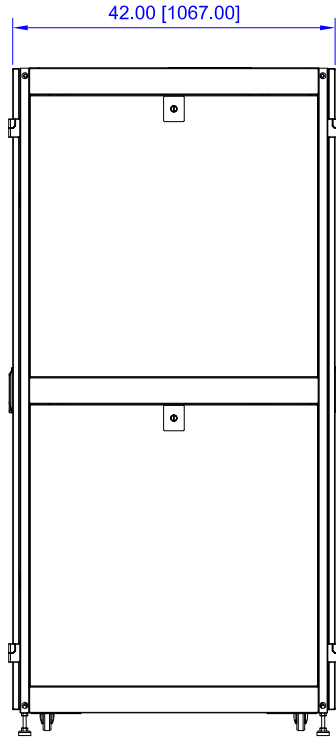

SIDE VIEW

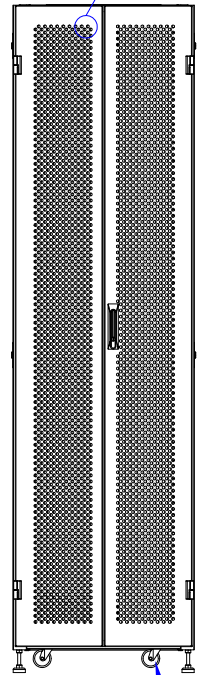

BACK VIEW

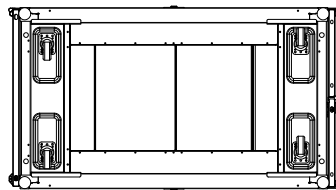

BOTTOM VIEW

12	2	PDU Lacing Panels	Steel	18 gauge
11	4	Cage Hole Mounting Rails	Steel	14 gauge
10	4	2.5" Dia. Casters		
9	4	Adjustable Levelers		
8	2	Adjustable Bottom Panels	Steel	18 gauge
7	1	Removable Fan Panel	Steel	18 gauge
6	2	Brush Panel Cable Entry		
5	1	Top	Steel	18 gauge
4	1	Split Panel Mesh Rear Door (standard)	Steel	18 gauge
3	1	Full Panel Mesh Front Door (standard)	Steel	18 gauge
2	4	Removable Side Panels	Steel	16 gauge
1	N/A	Cabinet Frame	Steel	18 gauge
NO	QTY	NAME	MATERIAL	THICKNESS

ITEM NO.		VC5-6A45-ABV1A*		VERICOM [®]
DESCRIPTION				
45U x 42"D SERVER CABINET				
DATE	SCALE	SHEET	REV	
04/14/20	none	1 of 2	1	

*VC5-6A45-ABV1A replaces RS0AB45-BV1A

All dimensions in inches [mm]

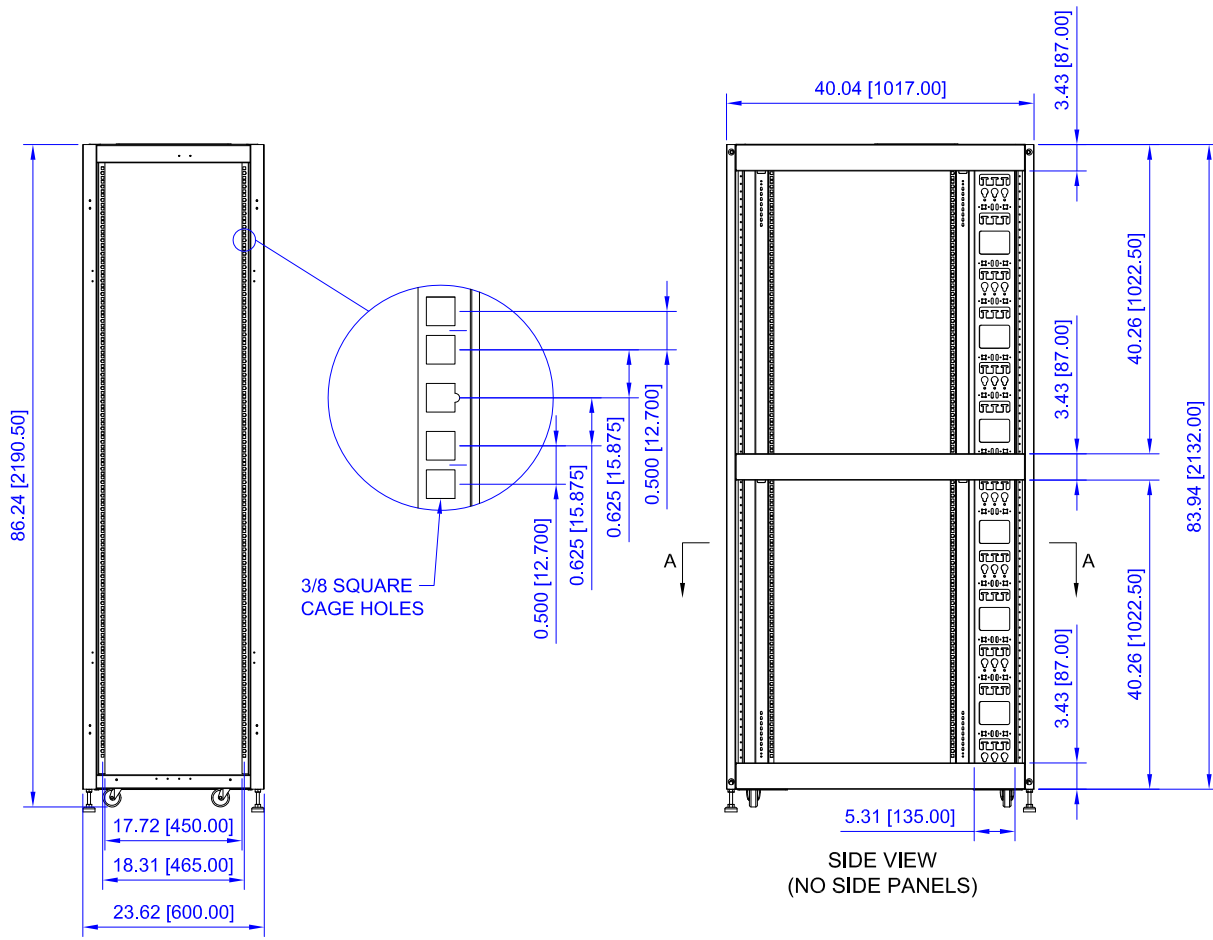

FRONT VIEW
(NO DOOR)

SIDE VIEW
(NO SIDE PANELS)

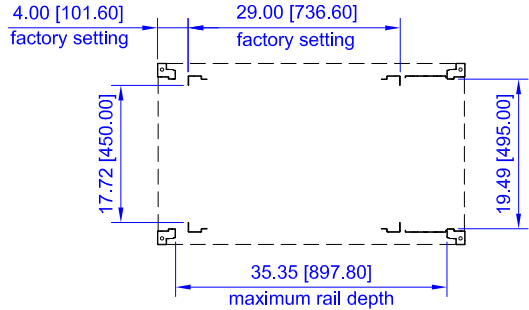

SECTION A-A

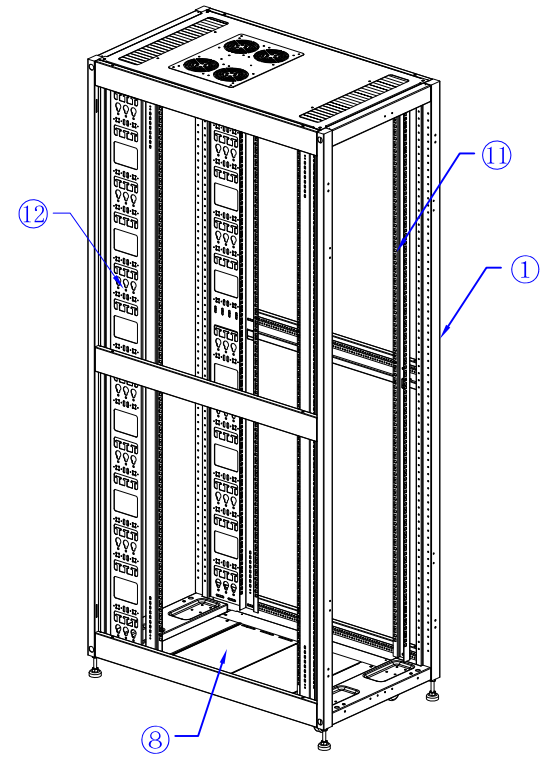

*VC5-6A45-ABV1A replaces RS0AB45-BV1A

All dimensions in inches [mm]

ITEM NO.	VC5-6A45-ABV1A*		VERICOM [®]		
DESCRIPTION	45U x 42"D SERVER CABINET				
DATE	04/14/20	SCALE	none	SHEET	2 of 2
				REV	1